

100-3368-TH (100mm Fixed Castor High Temperature Phenolic Wheel)

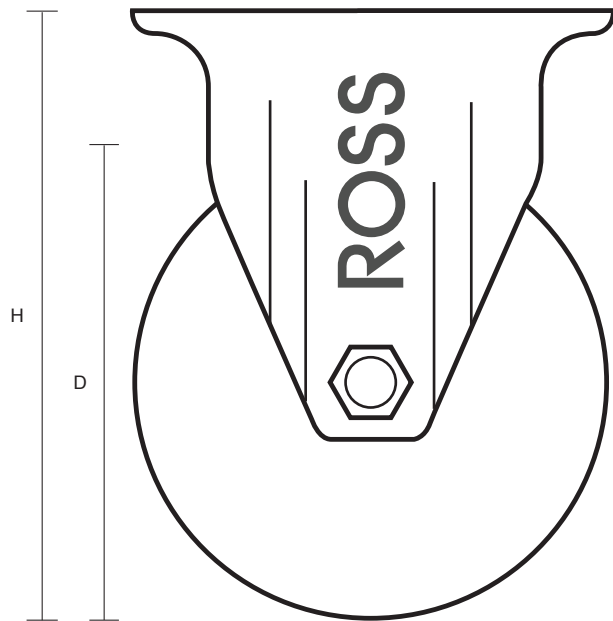
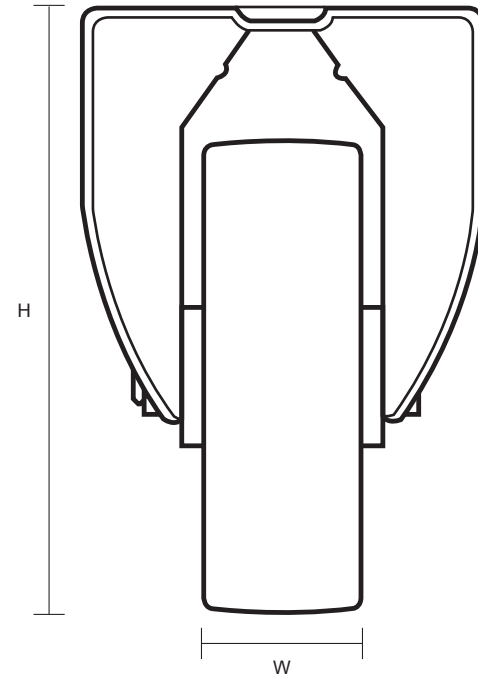
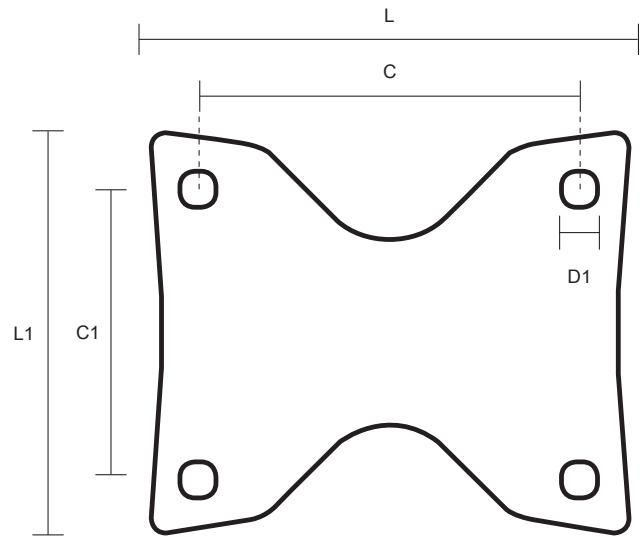

Castor Dimensions - Key		
D	Wheel Diameter (mm)	100mm
L	Plate Dimension Length (mm)	101mm
L1	Plate Dimension Width (mm)	85mm
C	Plate Hole Centers length (mm)	80mm
C1	Plate Hole Centers width (mm)	60mm
D1	Plate Hole Diameter (mm)	8mm
H	Total Castor Height (mm)	128mm
W	Tread Width (mm)	35mm
R	Swivel Radius (mm)	n/a