

160-5050-SUB (160mm Heavy Duty Fixed Plate Castor Polyurethane Tyred Wheel)

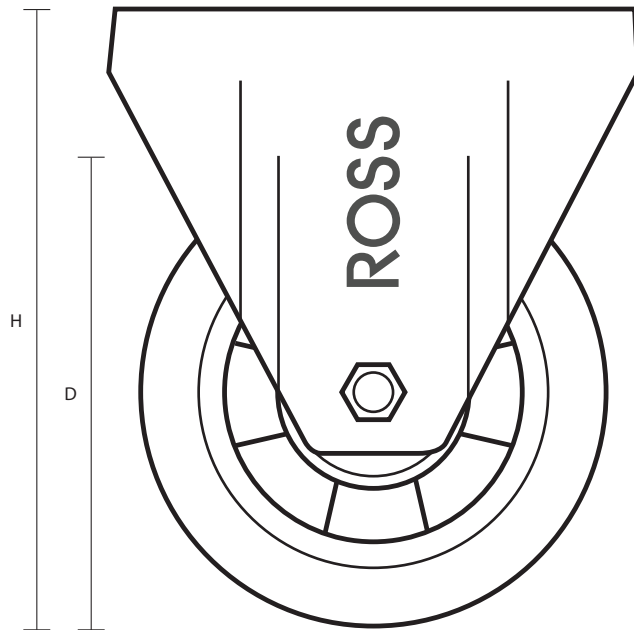
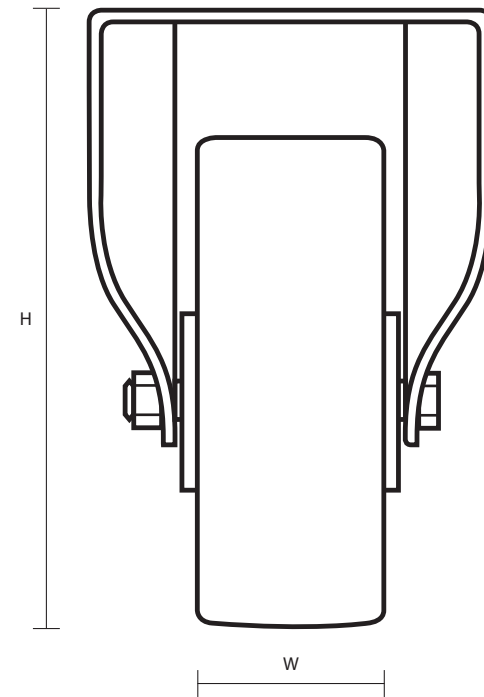
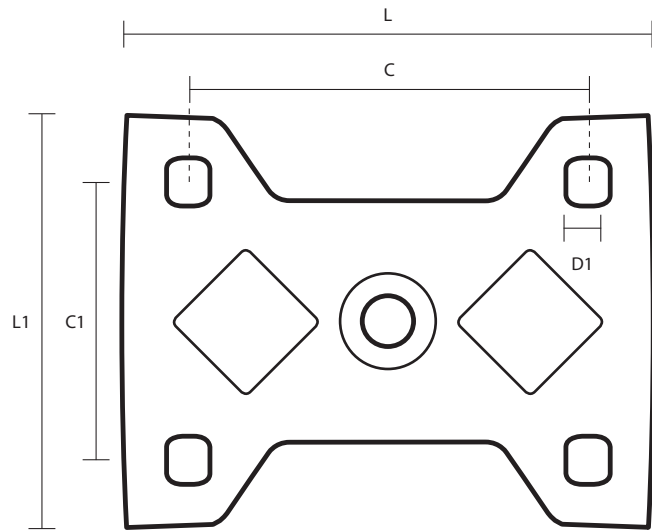

Castor Dimensions - Key		
D	Wheel Diameter	160mm
L	Plate Dimension Length (mm)	140mm
L1	Plate Dimension Width (mm)	110mm
C	Plate Hole Centers length (mm)	105mm
C1	Plate Hole Centers width (mm)	80/75mm
D1	Plate Hole Diameter (mm)	10mm
H	Total Castor Height	200mm
W	Tread Width (mm)	50mm
R	Swivel Radius (mm)	N/A