

JA4-080-PNB (Medium Duty Jacking Castor 80mm Polyurethane Tyred Wheel)

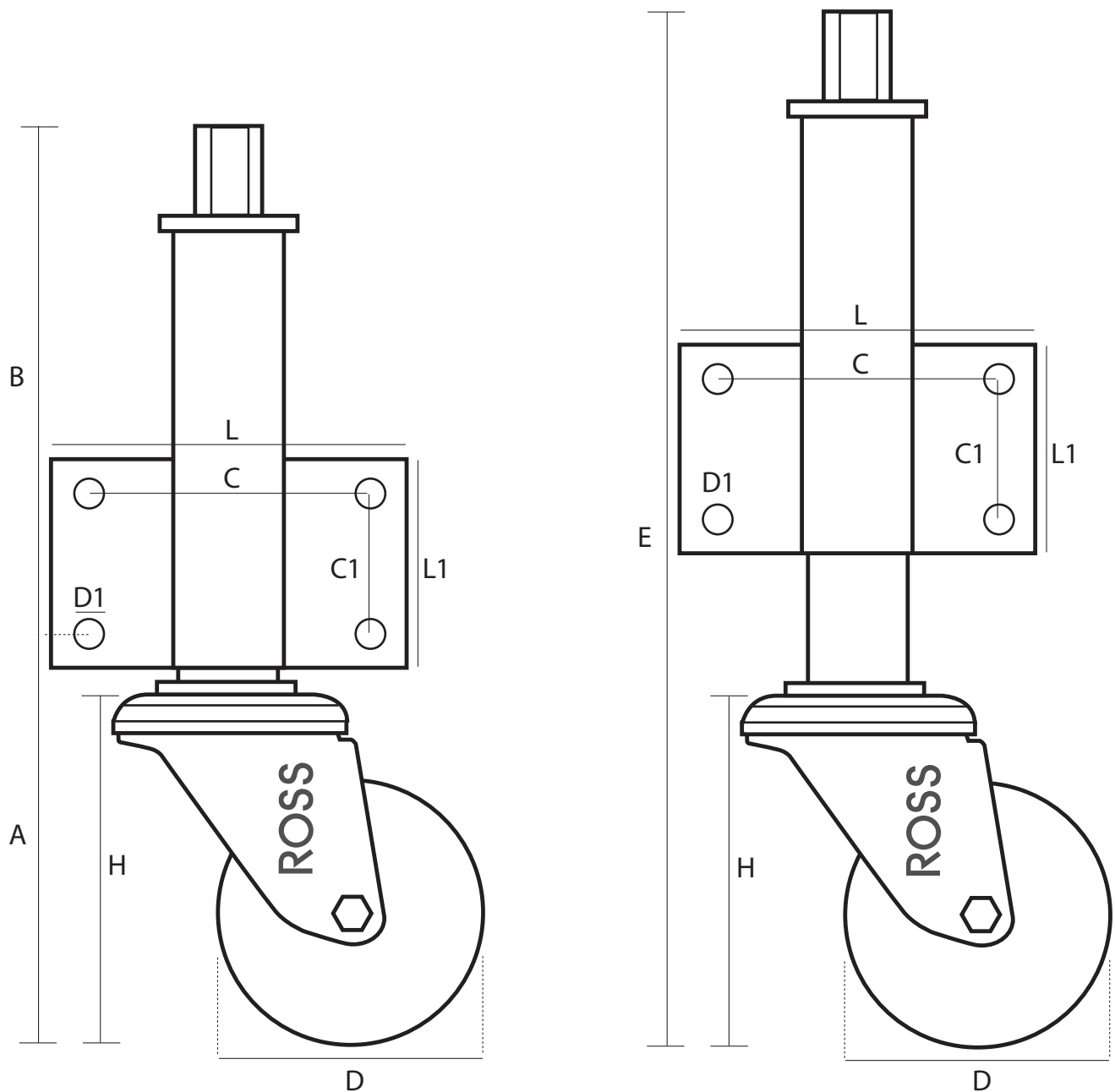

Castor Dimensions - Key		
D	Wheel Diameter	80mm
L	Plate Dimension Length (mm)	130mm
L1	Plate Dimension Width (mm)	75mm
C	Plate Hole Centers length (mm)	102mm
C1	Plate Hole Centers width (mm)	51mm
D1	Plate Hole Diameter (mm)	11mm
H	Total Castor Height	108mm
A	Total Height to Plate lower bolt hole	131mm
B	Jacking Unit Total Height from plate lower bolt hole	187mm
A+B	Min Total Jocking Unit Un-Extended Height	318mm
E	A+B+76mm Jacking Unit Extension Height	394mm