

LS100M10X25/B (100mm Twin Wheel Swivel Braked Castor With M10x25mm Thread)

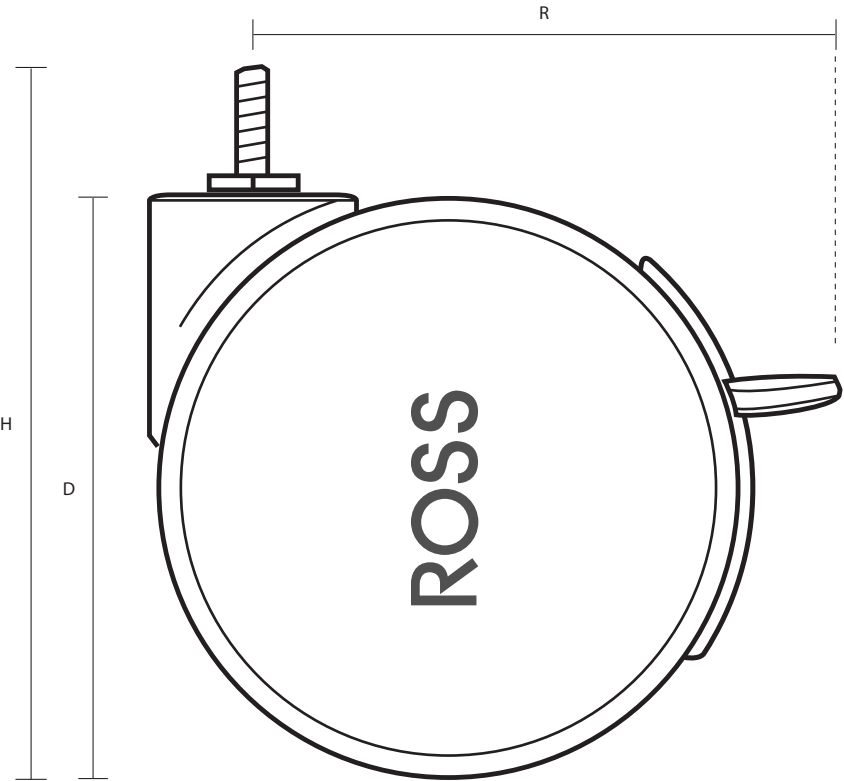
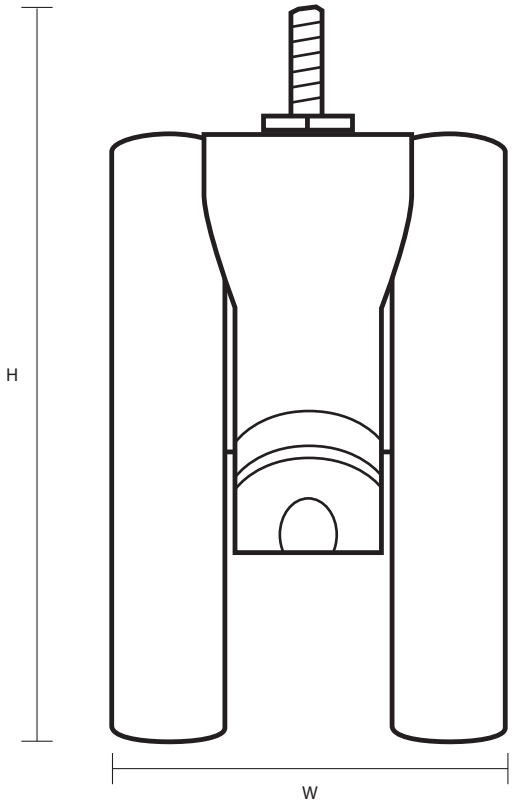
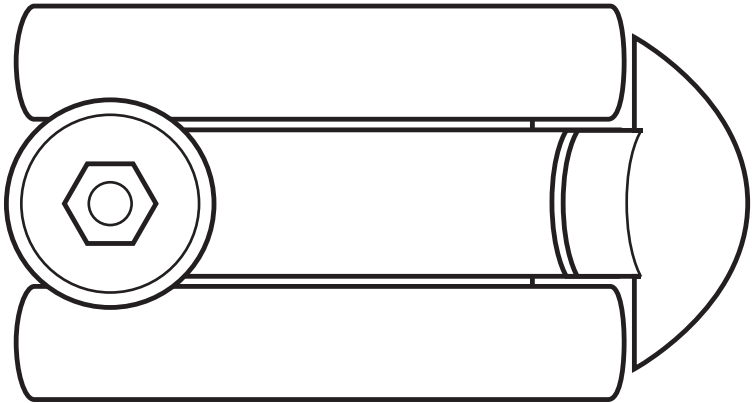

Castor Dimensions - Key		
D	Wheel Diameter	100mm
L	Plate Dimension Length (mm)	N/A
L1	Plate Dimension Width (mm)	N/A
C	Plate Hole Centers length (mm)	N/A
C1	Plate Hole Centers width (mm)	N/A
D1	Plate Hole Diameter (mm)	N/A
H	Total Castor Height	122mm
W	Tread Width (mm)	N/A
	Threaded Stem Size	M10x25mm