

SFL-125-ASR (125mm Stainless Steel Fixed Castor Anti-Static Wheel)

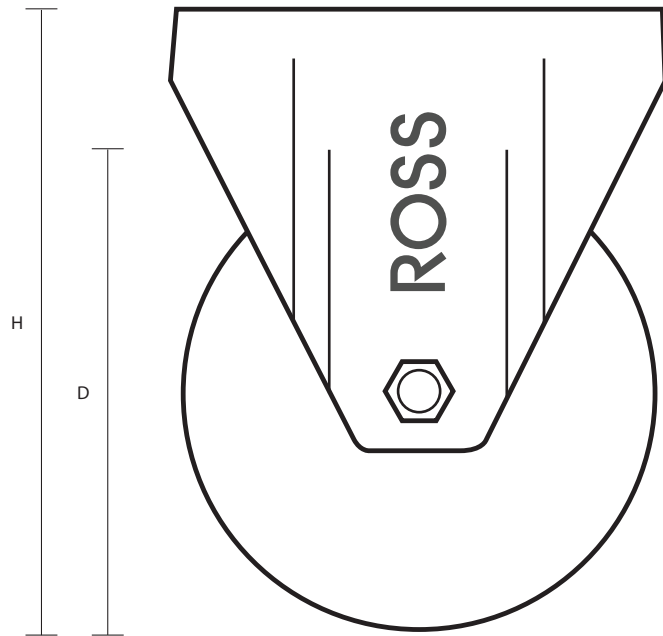
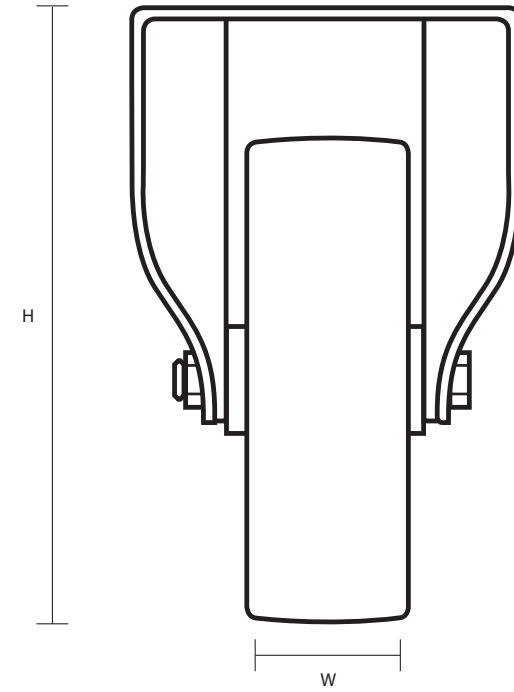
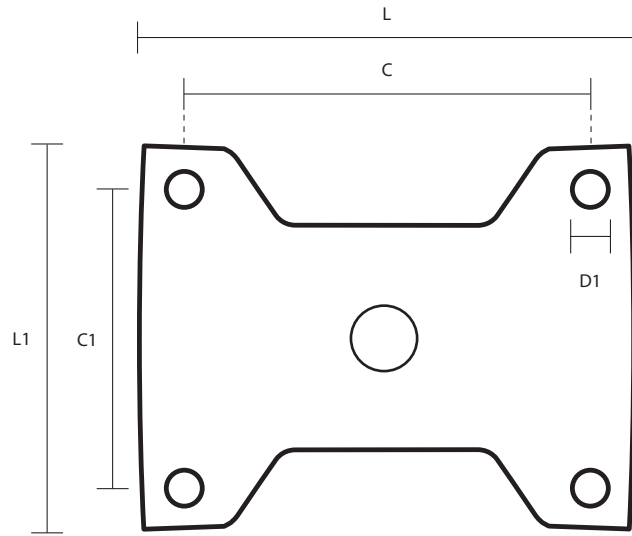

Castor Dimensions - Key		
D	Wheel Diameter	125mm
L	Plate Dimension Length (mm)	90mm
L1	Plate Dimension Width (mm)	70mm
C	Plate Hole Centres length (mm)	70mm
C1	Plate Hole Centres width (mm)	50mm
D1	Plate Hole Diameter (mm)	8mm
H	Total Castor Height (mm)	162mm
W	Tread Width (mm)	30mm
R	Swivel Radius (mm)	N/A