

SFL-60-ASR (60mm Stainless Steel Fixed Castor Anti-Static Wheel)

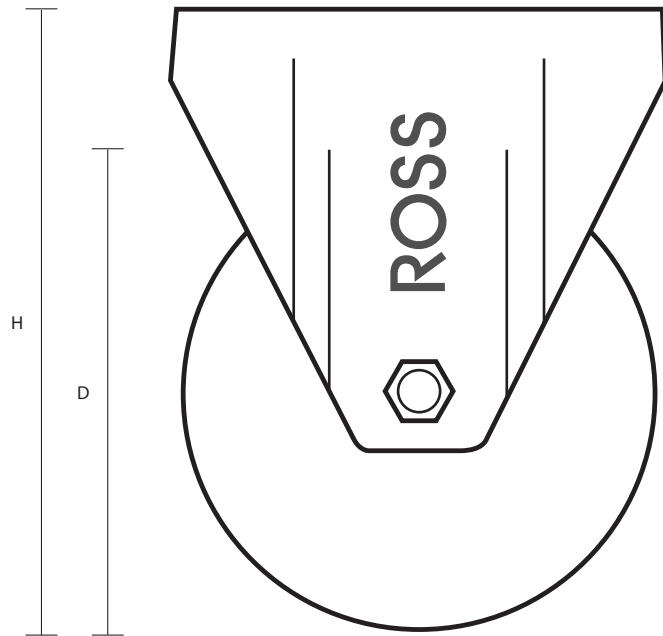
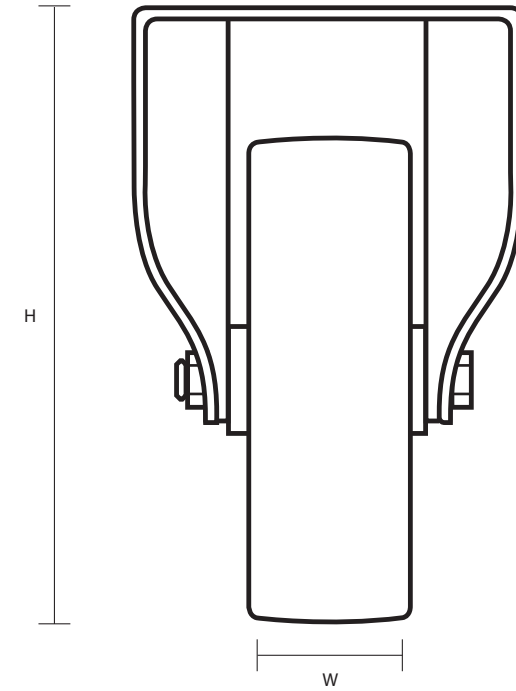
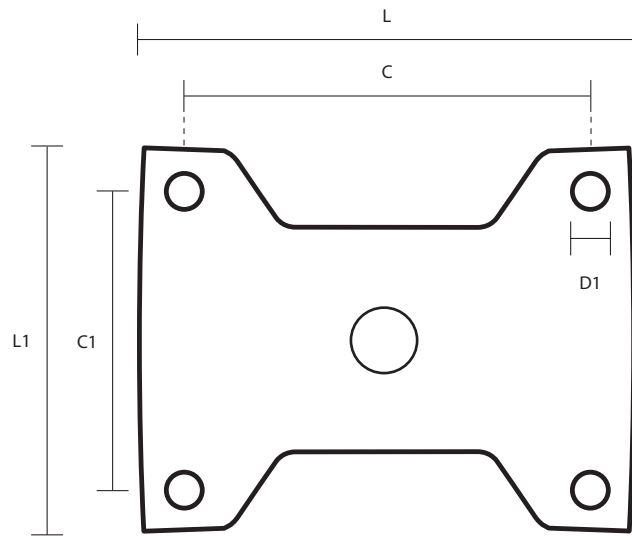

Castor Dimensions - Key		
D	Wheel Diameter	60mm
L	Plate Dimension Length (mm)	65mm
L1	Plate Dimension Width (mm)	54mm
C	Plate Hole Centres length (mm)	50mm
C1	Plate Hole Centres width (mm)	36mm
D1	Plate Hole Diameter (mm)	6mm
H	Total Castor Height (mm)	89mm
W	Tread Width (mm)	22mm
R	Swivel Radius (mm)	N/A