

SS-125-TH/SWB (125mm Swivel Braked Top Plate Castor High Temperature Phenolic Resin Wheel)

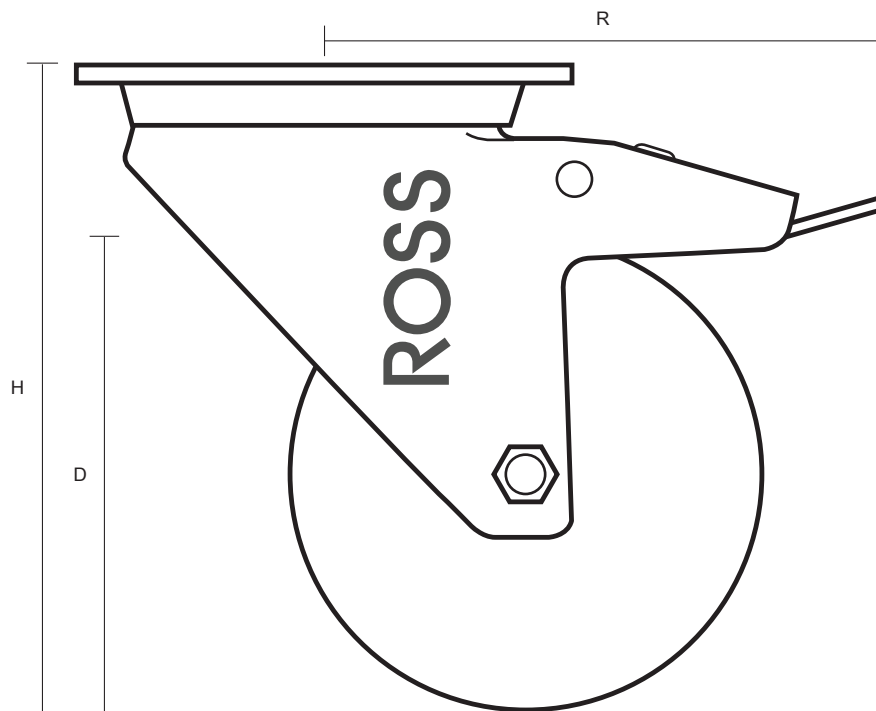
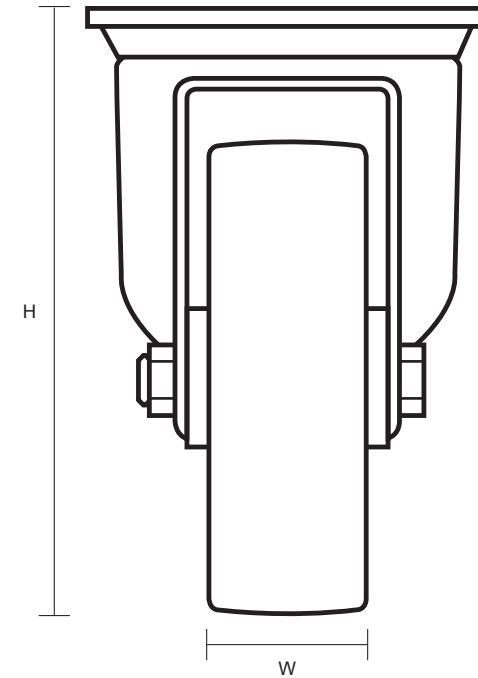
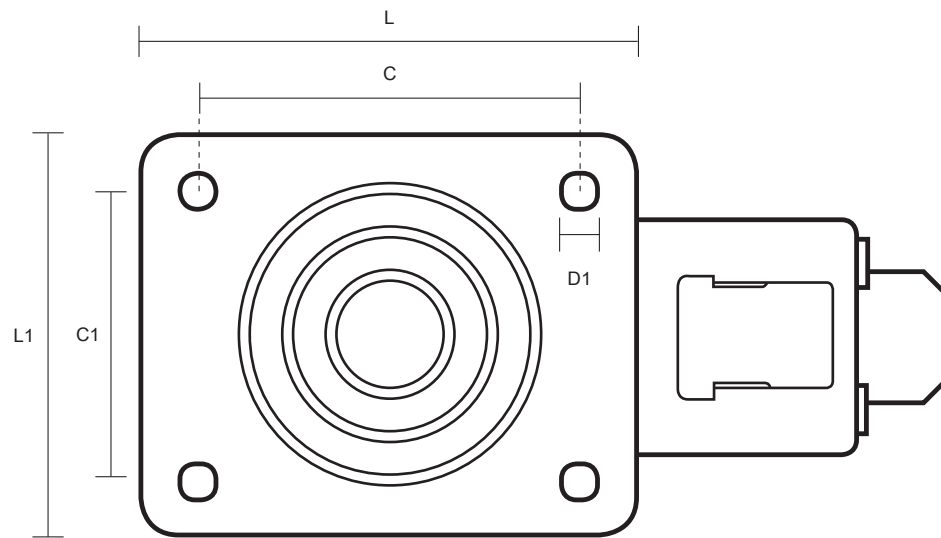

Castor Dimensions - Key		
D	Wheel Diameter	125mm
L	Plate Dimension Length (mm)	105mm
L1	Plate Dimension Width (mm)	85mm
C	Plate Hole Centres length (mm)	80mm
C1	Plate Hole Centres width (mm)	60mm
D1	Plate Hole Diameter (mm)	8mm
H	Total Castor Height (mm)	155mm
W	Tread Width (mm)	35mm
R	Swivel Radius (mm)	135mm