

# SS-200-TH/SWB (200mm Swivel Braked Top Plate Castor High Temperature Phenolic Resin Wheel)

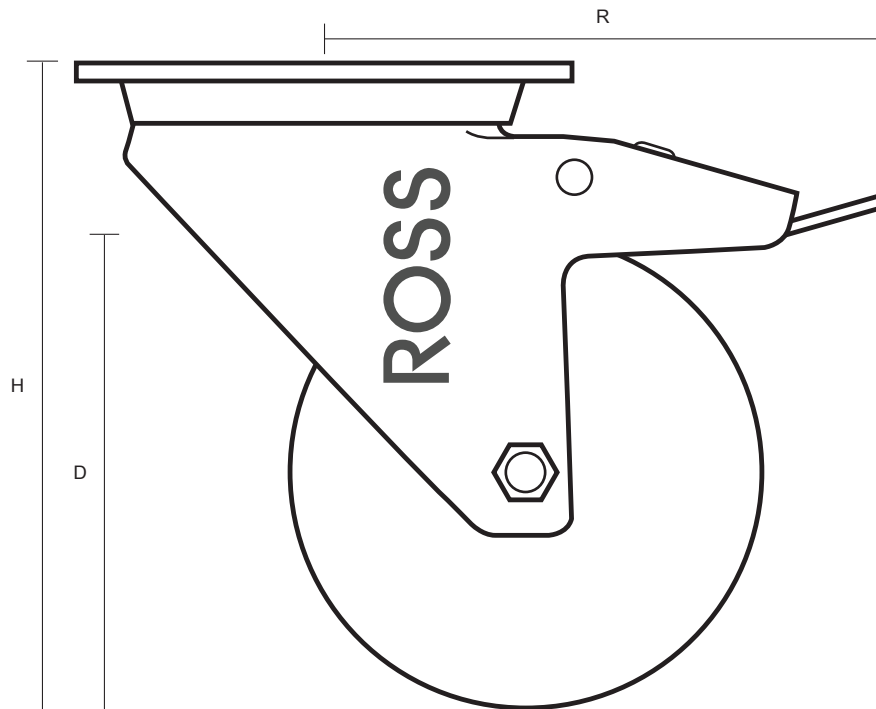
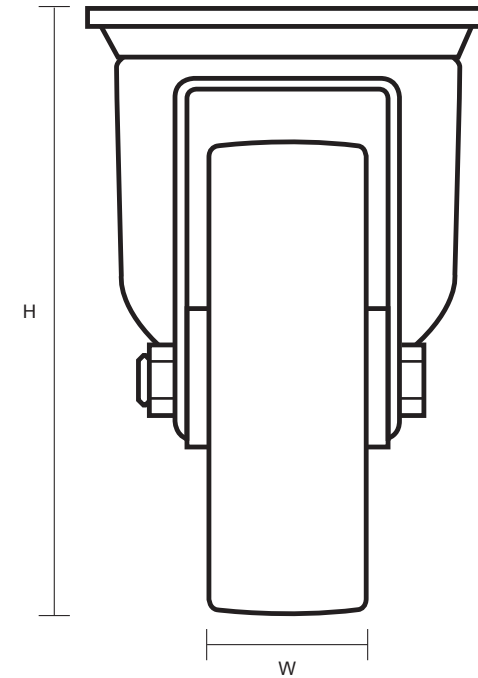
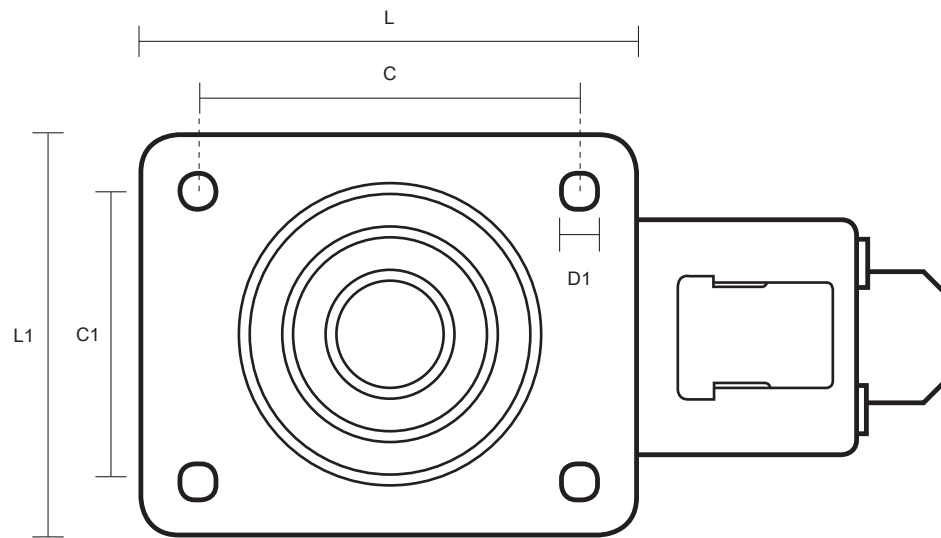

Castor Dimensions - Key		
D	Wheel Diameter	200mm
L	Plate Dimension Length (mm)	140mm
L1	Plate Dimension Width (mm)	110mm
C	Plate Hole Centres length (mm)	105mm
C1	Plate Hole Centres width (mm)	80/75mm
D1	Plate Hole Diameter (mm)	10mm
H	Total Castor Height (mm)	236mm
W	Tread Width (mm)	40mm
R	Swivel Radius (mm)	195mm